



TESS

Transactional Environmental
Support System

System Design and Pilot Implementation

**Prof Robert Kenward, TESS science
supervisor**

**Funded by the European Community's Seventh
Framework Programme (FP7/2007-2013) under
grant agreement n° 212304**

**ENV.2007.4.2.1.1. Methodologies for scaling down to regional
& local level the analysis of policy impacts on multifunctional**

land uses & economic activity



GANTT-like TESS work-packages

0
M
O
N
T
H

12

24

33

WP2
Central
Survey
design

Workshop
& report

WP5
Cases

Pan-Euro
local &
central
survey

Local
mapping &
projects &
report

WP3
Local
Survey
design

Workshop
& report

WP6
Policy +
Internet

Survey,
analysis

WP4
Models

Audit of
models

Database
complete,
reported

Gap
analysis

Relationship between TESS work-packages

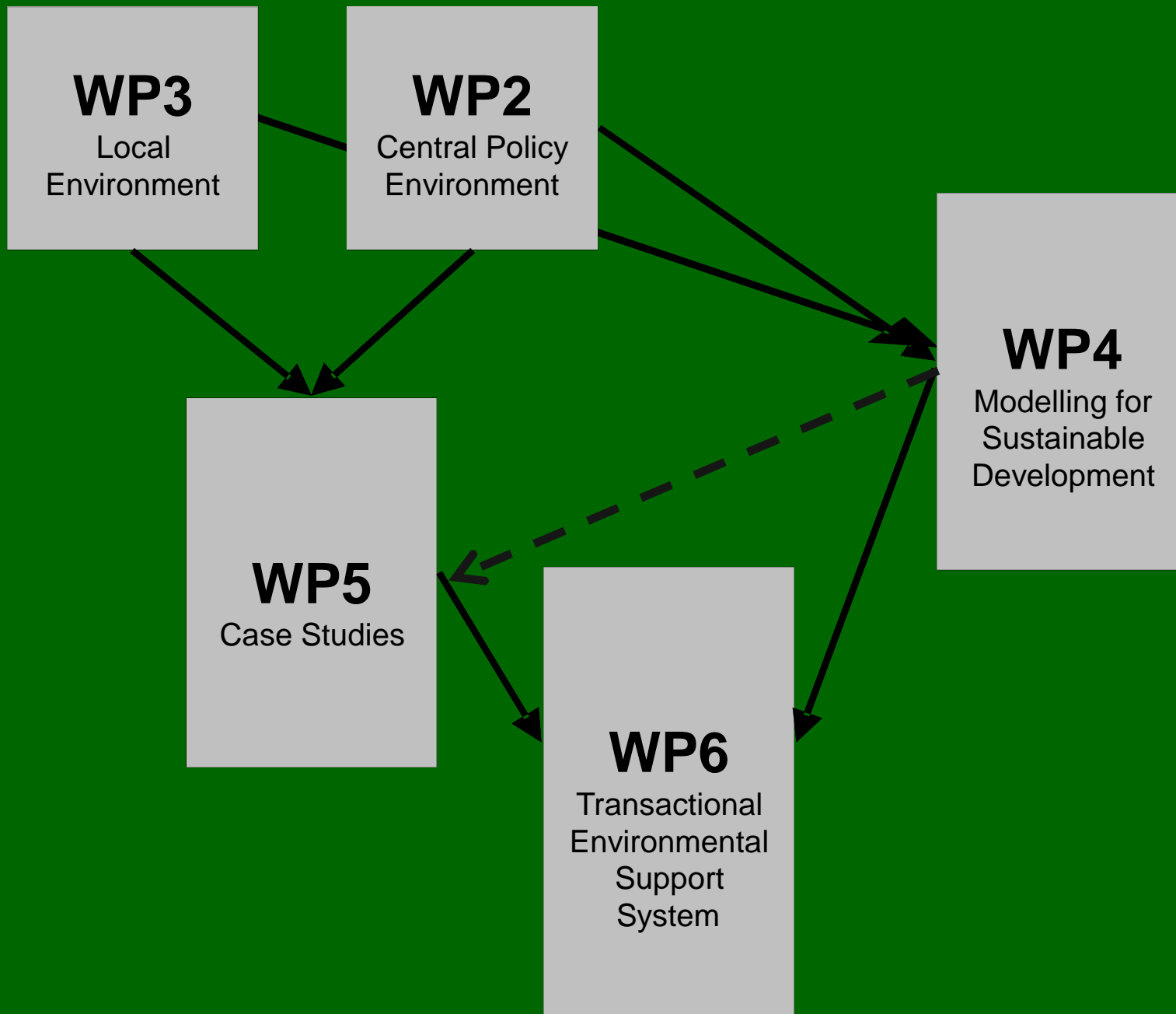

GANTT-like TESS work-packages

0

M
O
N
T
H

12

WP2
Central
Survey
design

Workshop
& report

WP5
Cases

Pan-Euro
local &
central
survey

Local
mapping &
projects &
report

WP3
Local
Survey
design

Workshop
& report

WP6
Policy +
Internet
Survey,
analysis,

TESS
internet
design &
report

Policy
document

WP4
Models
Audit of
models

Database
complete,
reported

Gap
analysis

24

33

WP6 Deliverables

D6.1 Report on biodiversity trends with SEA & EIA practices across Europe.

D6.2 Recommendations and guidelines.

D6.3 Design of a Transactional Environmental Support System.

(i) Technical design (Mapping, Decision Support

(ii) Socio-economic attractiveness of the tool.

D6.4 Report on Brussels workshop.

Task 6.3

(i) Technology Design

1. Technology design – need to agree:
 - (a) high level requirements (e.g. inference engine logic, scale, confidentiality, data supplies, ownership & payments etc)
 - (b) specifications for design:
 - Domain Model,
 - Use Cases,
 - cost for building.
 - (c) priority areas for decision support.
- Meetings with CEH Feb, Sept 2009, Sept 2010
- Workshop 13-15 December (Edinburgh)
- Workshop 25 May 2011

High level requirements

1. The system shall be web based initially, but its architecture must be flexible enough that alternative frontends may be developed (web services, applets, cloud, etc).
2. The system must be able to contain socio-environmental data (spatial data, map images and mathematical models) and models in various formats and for various locations.
3. All data and models used in the system will be tagged by origin, as public or private and with other appropriate meta-data.
4. The system shall also support standardized data-bases on private computers, on which the user can change data, mark it public or private, and use it with appropriate models in personal computers or on the system.
5. Public data will be acquired by the system, but may be changed by system or originator.
6. Models may be acquired by the system for its use on a public or commercial basis.
7. The user and the system must be able to make requests for data and models of third-party databases, providing payment for access where necessary.
8. The user must be able to compare data and models from different sources and otherwise check for validity.
9. The system must be able to verify and check data and models for integrity.
10. The system must be able to accept subscriptions and payments on account for models and data.
11. The system must be able to present itself and interact with the user in many languages.
12. The system must be embeddable into associate partners' websites using a standard frontend.
13. The user must be able to create a user account so that the system remembers the user's details (name, address, subscription and account details) at login.
14. The system shall maintain a list of accounts in its central database.
15. When a user logs in, his/her password must always be matched against the passwords in the master account list.
16. The user must be able to search for data by various search methods - location, type, keyword, date and so on – and then view the data tags.
17. The user and system must be able to apply models and Bayesian analysis in data and produce scenarios.
18. It must be possible for the user to post comments on the data and models.
19. Comments must be moderated – that is to be checked and permitted by a member of staff before they are published on the website.
20. The system must be able to perform vector/raster and coordinate conversion from all projections, and to interact with large external databases (e.g. CORINE).
21. The system shall be scalable, with the following specific requirements:
 - The system must be capable of maintaining user accounts for up to 100,000 users in its first six months and a further 1,000,000 after that.
 - The system must be able to of serving up to 1,000 simultaneous users (10,000 after six months).
 - The system must be capable to accommodate up to 100 search requests per minute (1,000 per minute after six months).
 - The system must be able to accommodate up to 100 data exchanges per hour (1,000/hour after six months).

Domain network

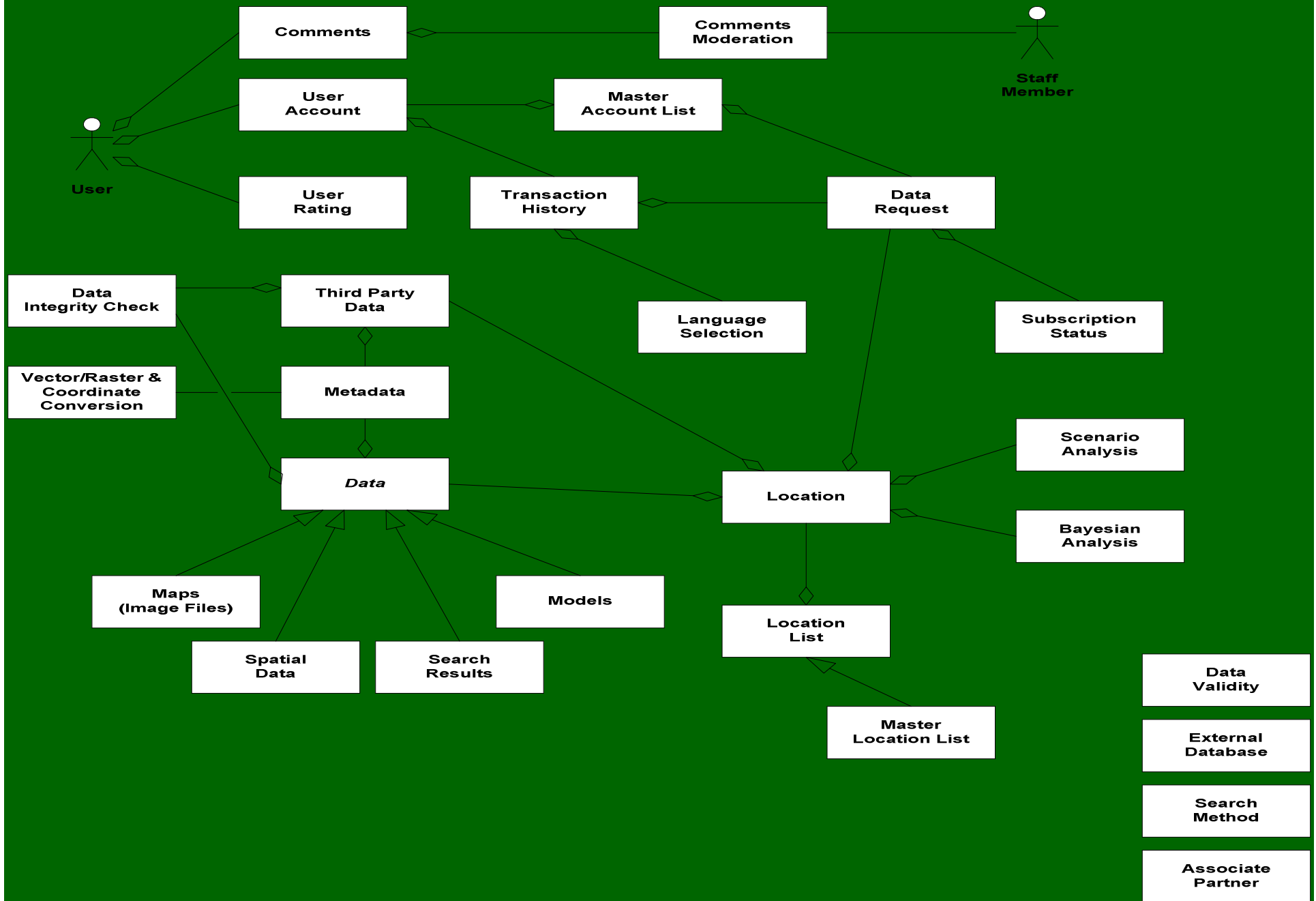

Use cases (e.g. Model Selection) to populate the domain network

	ALL SCALES	Functions											
		Run model selected	Run data input use case	Run data transformation Use case	Run data search Use case	Identify models with compatible input data	Identify models with compatible output data	Identify models that operate at the appropriate scale	Identify model(s) with 'best fit' to data supplied and output requested	Identify additional data needs	Identify data transformation needs	Identify options to link models	Model selection by user
Actor	General User					yes	yes	yes	yes	yes	Yes		yes
	Local level stakeholder, Local community, Policy manager					yes	yes	yes	yes	yes	yes		yes
	Decision tool / Domain expert	yes	yes	yes	yes	yes	yes	yes	yes	yes	yes	yes	yes

Lots more Use Cases

Use case	Partner	bee example	recreation (4x4)	Buffer strips in agricultural land	Managed fishery on a lake	Plant trees on this piece of land	Actors and their 'privileges'	Ability to run 'iteratively'	Help information for confidential data	Servicing different level users	Data validation policy	Sensitivity analysis to identify least 'reli-	Computational requirements(e.g. for pro	Data tagging – ownership and uncertain	Model evolve or static (it can create new	List of open source Bayesian tools	Amount of empirical data input over tir	Which items are flagged as issues in ou	Defining the actors	Vector vs Raster within Use Cases	Translation to national languages	Biodiversity gap analysis (What is there
Issue setting	IST	x	x	x	x		x	x	x									x	x			x
Criteria setting	Kristjan Piirim	x	x	x	x		x	x	x										x			x
Scenario builder	CEH	x	x	x	x		x	x	x			x		x				x	x			x
Model selection	CEH	x	x	x	x						x	x		x			x			x		x
Data entry & modification	workshop	x	x	x	x		x		x	x	x	x		x	x		x		x		x	x
Data search	AUTH	x	x	x	x						x			x			x					x
Data quality assessment	CEH	x	x	x	x				x	x	x	x		x			x	x				
Error/uncertainty assignment	CEH	x	x	x	x			x			x	x	x	x			x					
Display outputs	AUTH	x	x	x	x		x		x			x	x					x			x	x
System options (menus, etc)	from design	n/a	n/a	n/a	n/a			x		x		x			x			x			x	x
Bayesian analysis & updating	CEH	x	x	x	x			x				x				x	x					x
Display Bayesian output	CEH	x	x	x	x													x				x
Scenario outputs	CEH	x	x	x	x			x		x			x					x			x	x
Help	from design	n/a	n/a	n/a	n/a				x		x	x	x		x				x		x	x
Vector/raster & coordinate conversion	Anatrack	x	x	x	x								x	x	x					x		
Data aggregation & disaggregation	AUTH	x	x	x	x					x			x		x		x			x		
Spatial analysis	Tero	x	x	x	x						x	x	x	x	x					x		
Log in	Anatrack	x	x	x	x		x			x									x		x	
Registration	Anatrack	x	x	x	x		x			x									x		x	
Translation to national languages	Anatrack	x	x	x	x		x		x									x			x	
Knowledge gap analysis	from design	n/a	n/a	n/a	n/a					x			x		x			x				x
Credits for data and model use	Tero						x			x			x	x		x					x	

Bayesian Logic handles uncertainty

e.g. Bayesian Belief Network for
Generic land use decisions

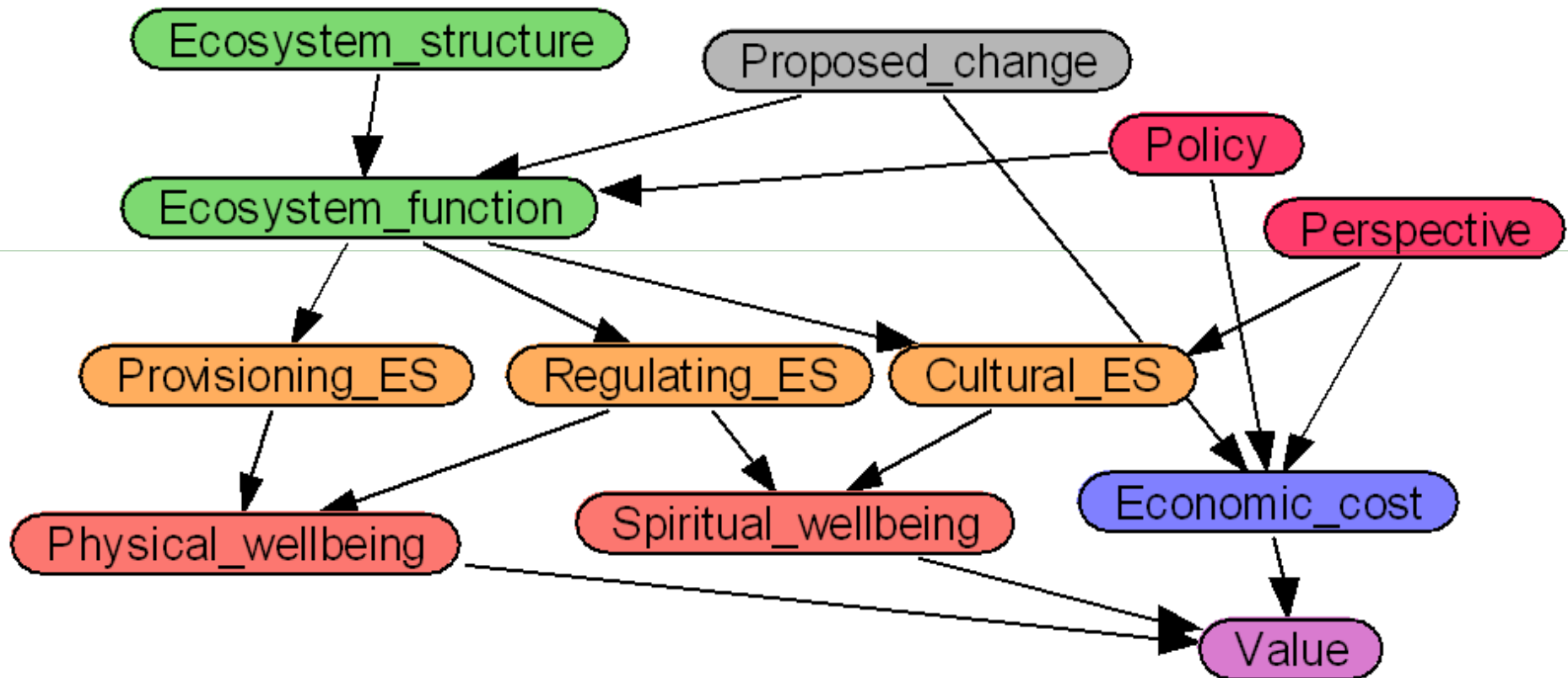

Bayesian Belief Network to explore decisions on hedge planting

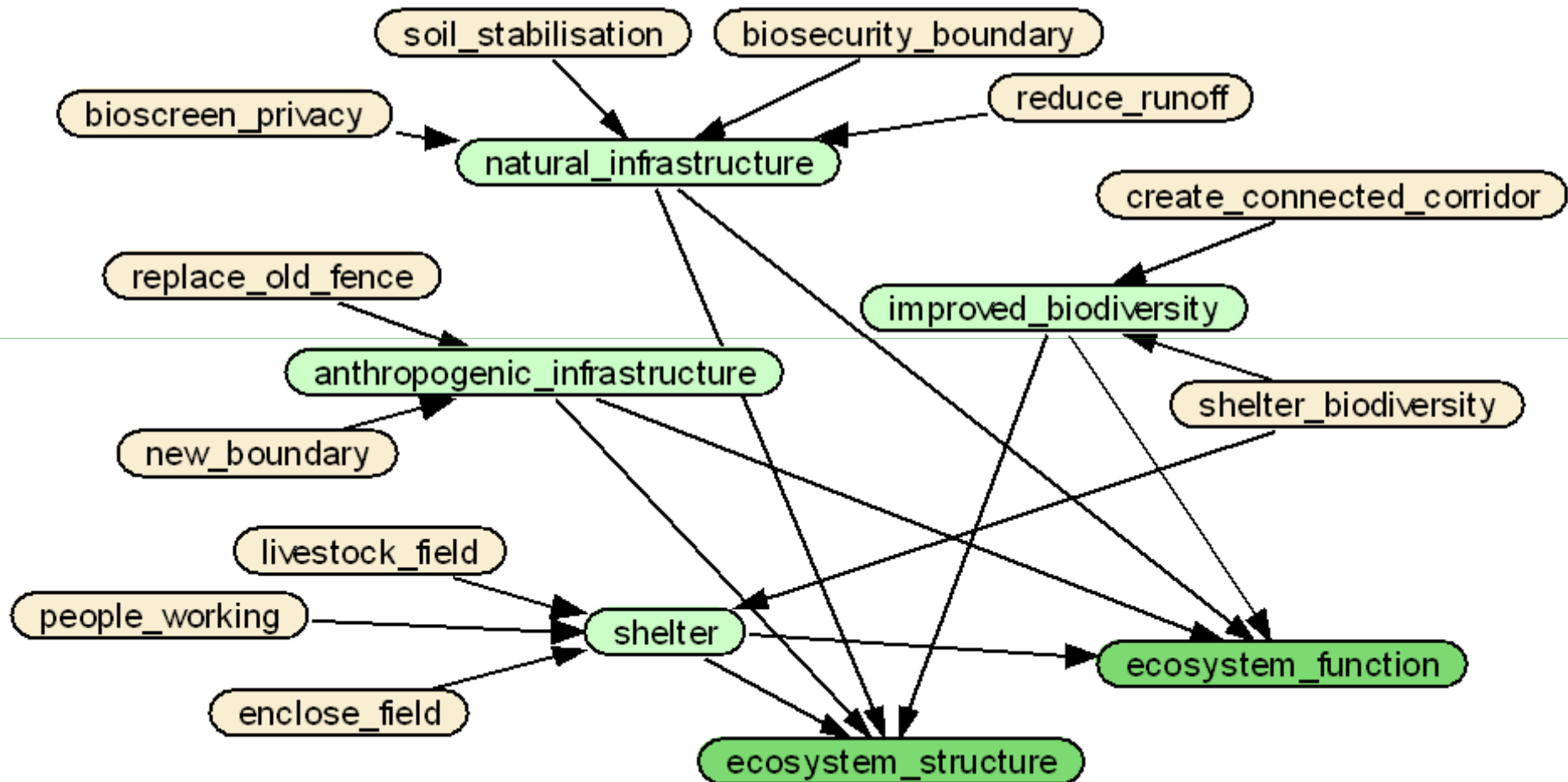

Example of a hedge line selected for planting by the farmer. The line was in an old ditch and offered habitat conductivity for biodiversity.

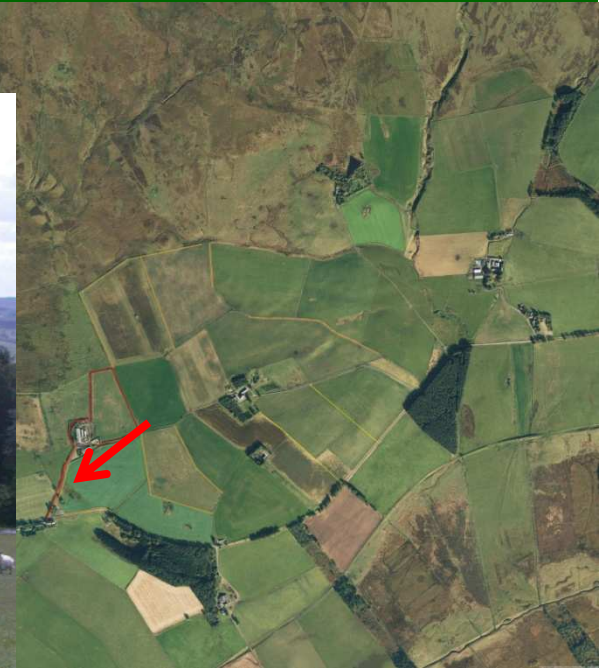

A simple BBN parameterised with 250 example hedge lines reveals almost 25% of hedges were planted without an interest in livestock.

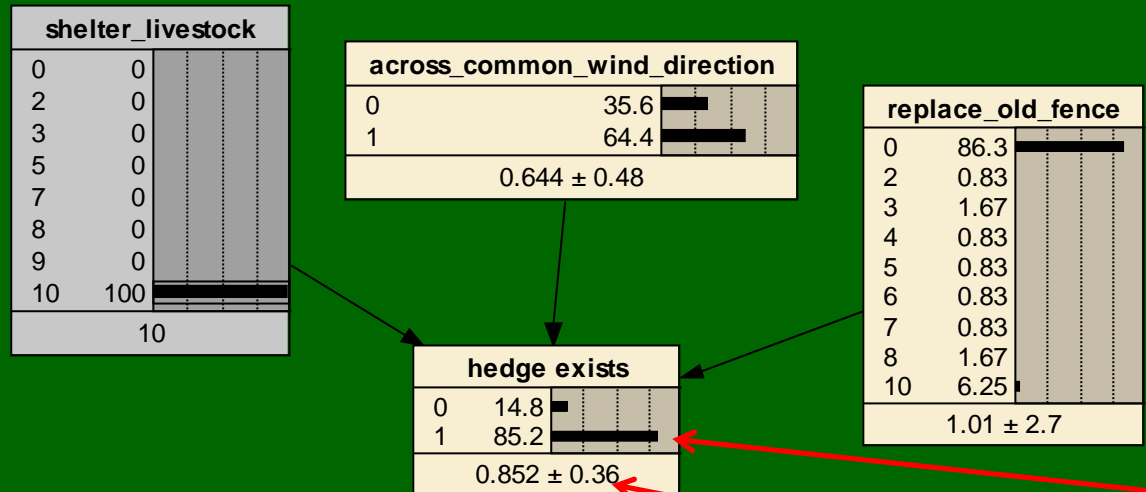
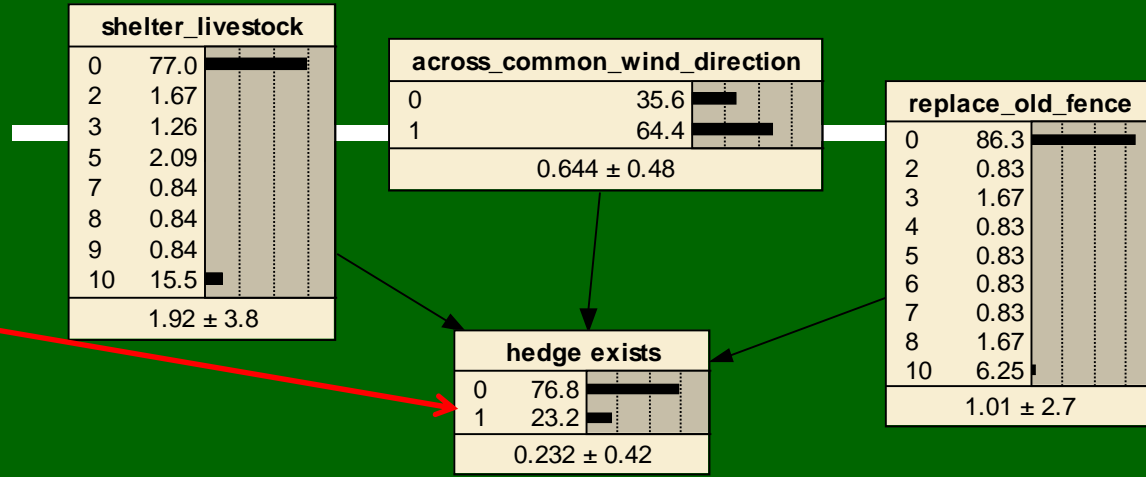

However if the farmer prioritised a need to shelter livestock, the BBN predicts using our test dataset that there would be an increase to 85% of hedges planted with a 36% uncertainty

Integrated modelling is not new so recall past lessons

- NERC-ESRC Land Use Programme (“NELUP”)
- 1989 -1995 £1.2 million (ca 60 man-years)
- Catchments of Rivers Tyne (mixed) and Cam (intensive arable)

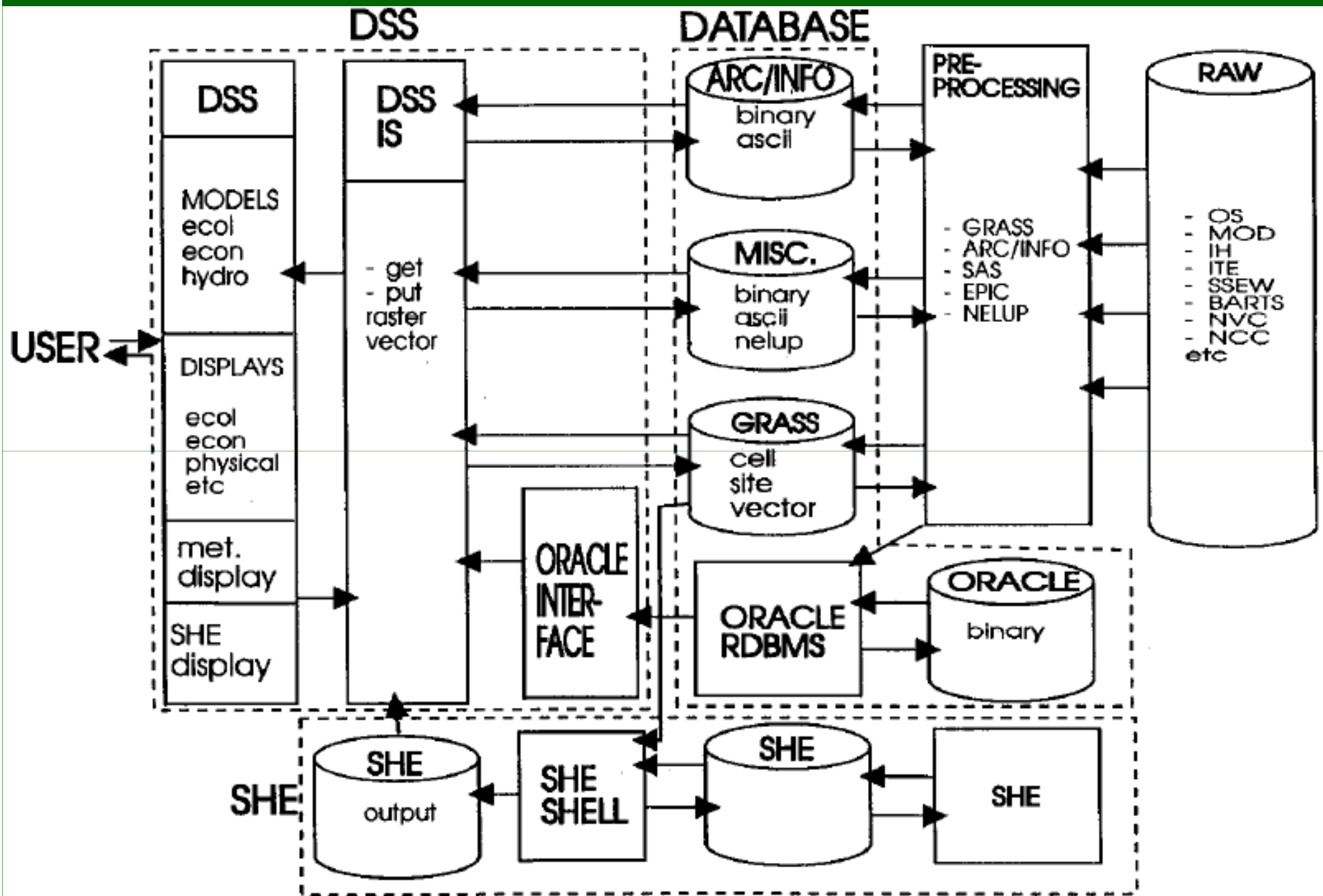

Also 2001 Environmental Information System for Planners (EISP)

A prototype demonstrator to help planners apply environment data and understanding in the planning process.



Origin: BGS, CEH and Nottingham University



Managing Waste

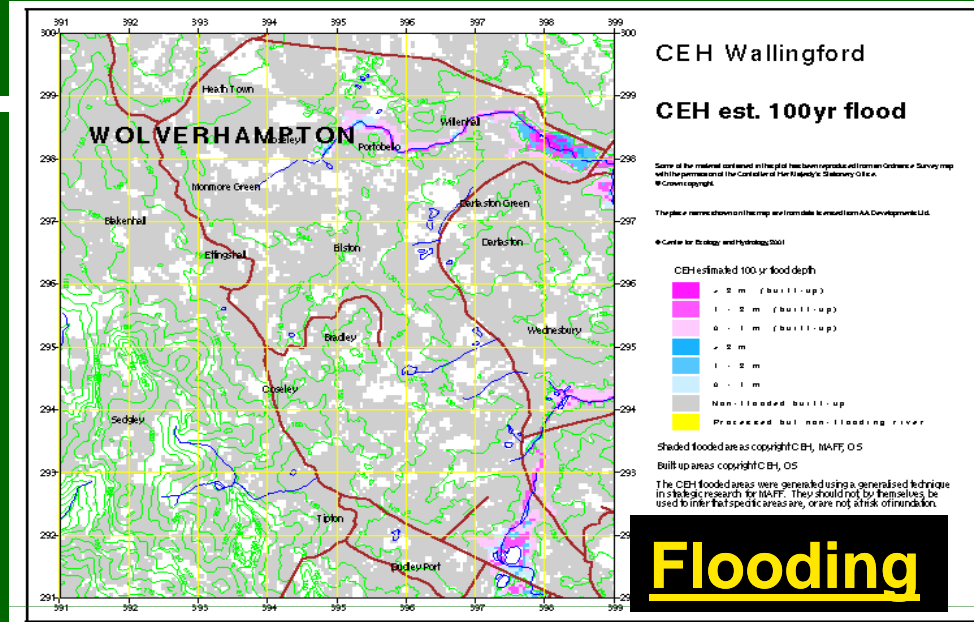

Flooding

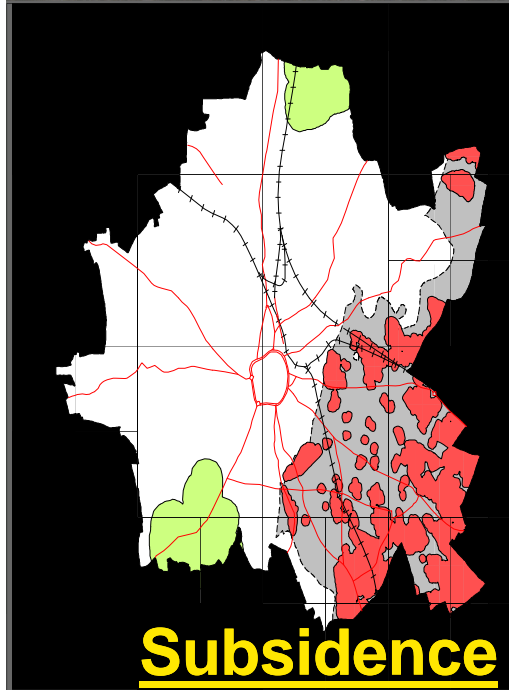

Subsidence

UNDERMINING

- Exposed coalfield. Risk of subsidence over former workings
- Exposed coalfield. Areas of potential subsidence over undocumented workings
- Possible minor subsidence relating to modern deep mining

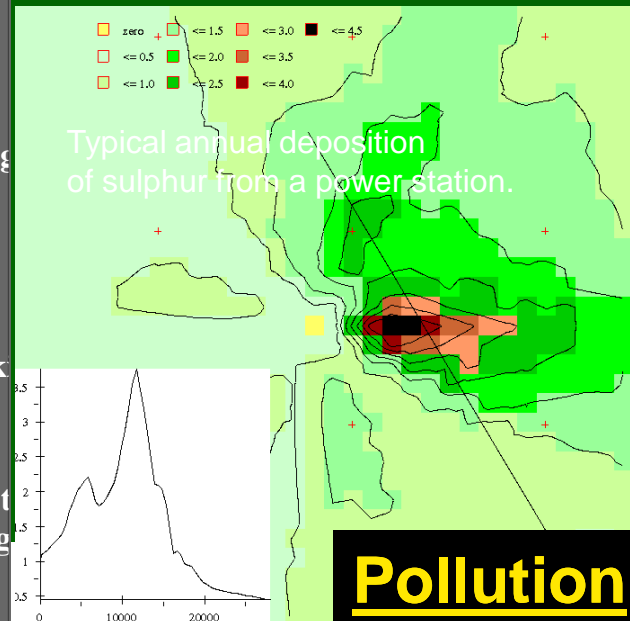

Pollution

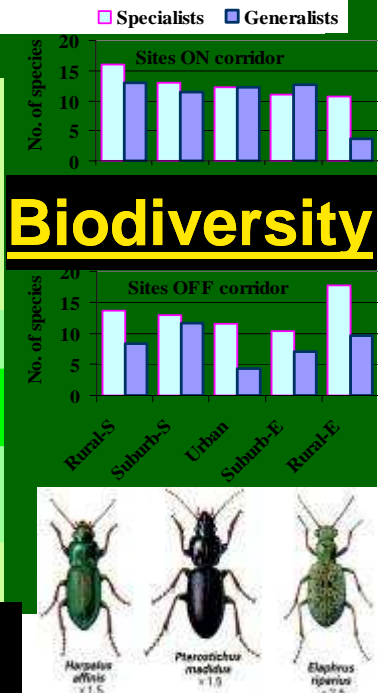

Previous Integrated Models

- NERC-ESRC Land Use Programme (“NELUP”)
- 1989 -1995 £1.2 million (ca 60 man-years)
- Catchments of Rivers Tyne (mixed) and Cam (intensive arable)
- Environmental Info. System for Planners
- **Conclusion**: identifying users/stakeholder is critical (most models developed in NELUP were never used); and involve them formally throughout the project life-cycle

The challenge of Sustainable Technology

Q. How to get people to use a conservation-through-use TESS that benefits biodiversity?

A. By building it into a portal that is very attractive because it benefits livelihoods and recreation of those using land and species. A one-stop-shop for the environment.

Q. How to design that portal & fund the build?

A. By asking (a) **organisations** AND (b) **individuals** what services they would like it to provide AND what they are prepared to pay.

Task 6.3

(ii) Socio-economic Design

1. Technology design

- Meetings with CEH Feb, Sept 2009, Sept 2010
- Workshop 13-15 December (Edinburgh)
- Workshop 25 May 2011

2. Socio-economic design - how to deliver to

(a) **stakeholders** (b) **their NGOs/consultants**
(c) **local authorities** (d) higher government levels.

- Meeting with stakeholders February 2010
- Survey of Organisations summer 2010
- Survey of Individuals summer 2011



WP6 surveys & TESS implementation

- 1. Survey by FACE of needs of organisations for users of environmental resources;**
- 2. Creation of external portal using priorities of the responding stakeholder organisations;**
- 3. Inflow from individuals of more extensive data on information priorities and willingness to pay;**
4. Write-up socio-economic design findings in and present to European Commission;
5. Further portal development beyond TESS based on interest in site and willingness to pay.

On which environmental topics would your members or clients most welcome information?

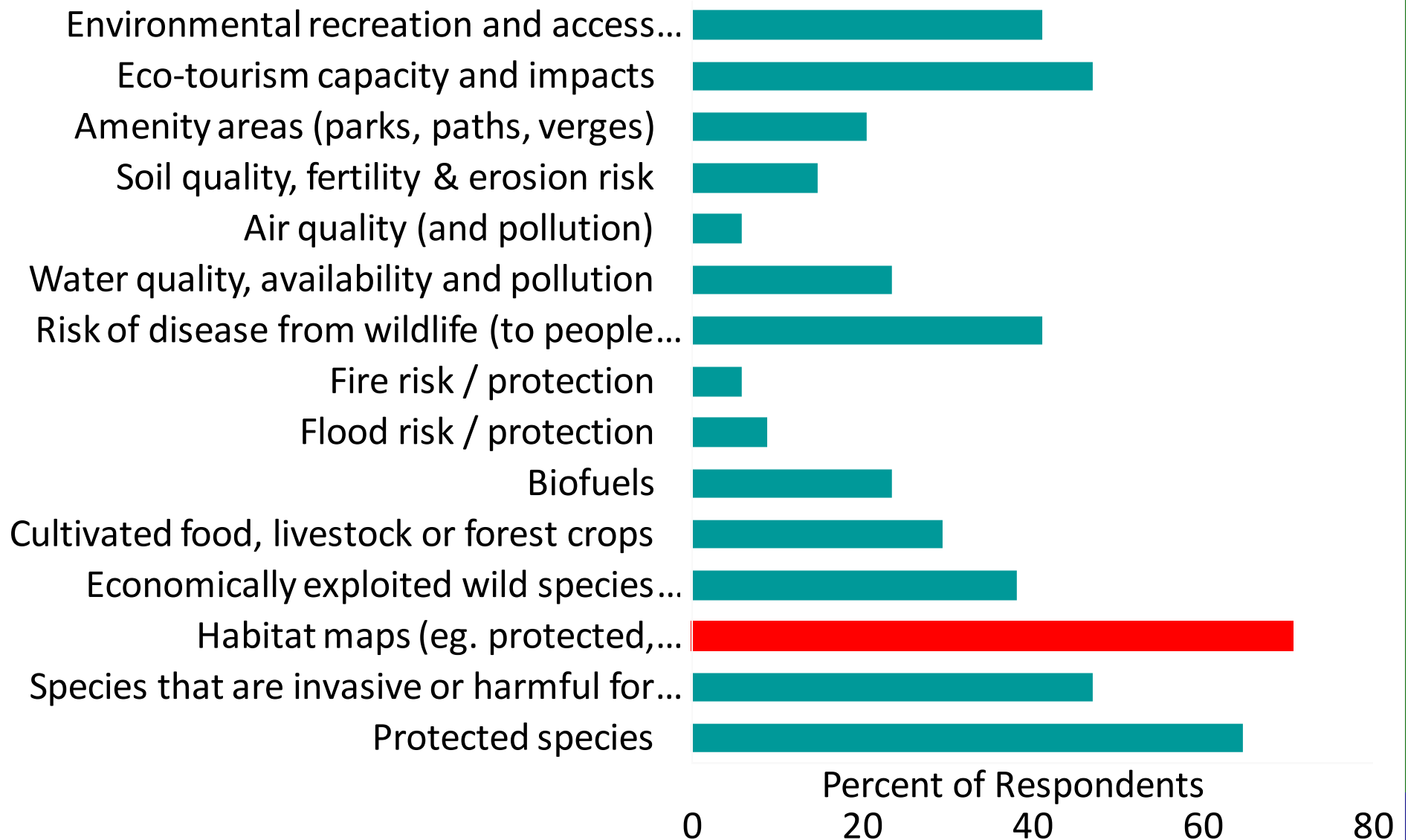

What features are on your website and what would you like on an ideal site?

■ Present ■ Prioritised ■ Aspiration

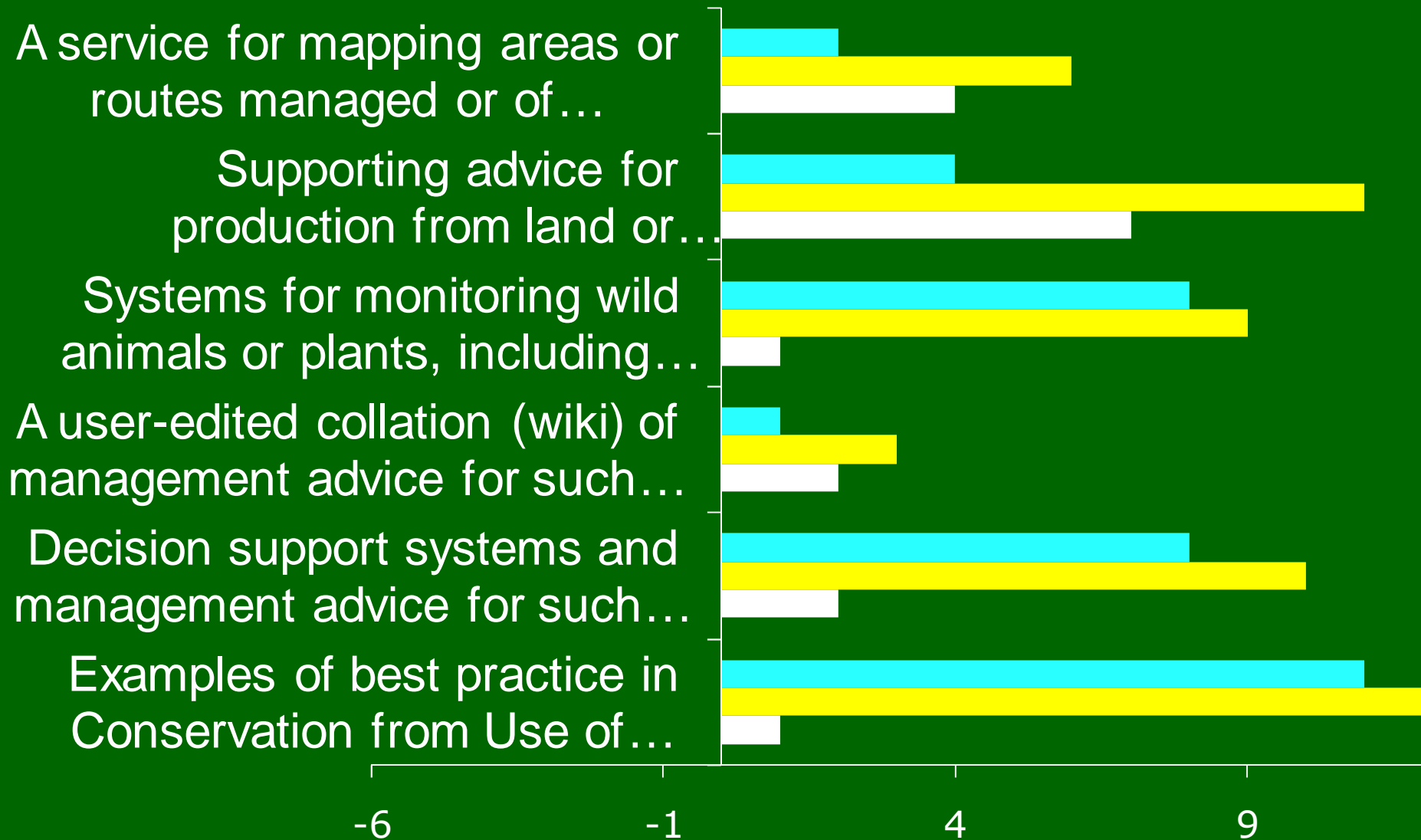

What features are on your website and what would you like on an ideal site?

■ Present ■ Prioritised ■ Aspiration

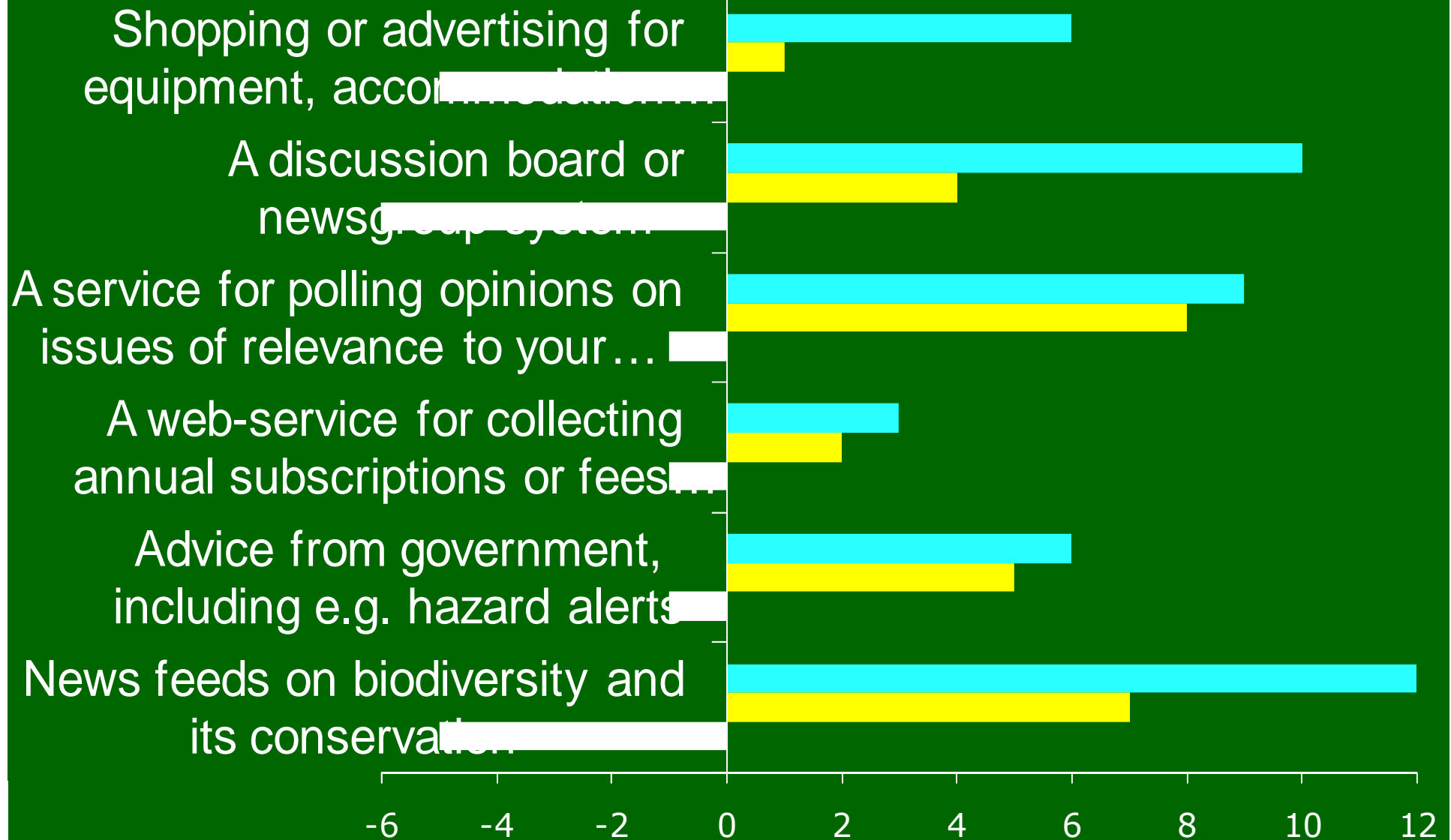

Ülke ve dil seçiniz



Saada

Species Survey Co

ga ühenduse võtmiseks täitke v
ge nupule Saada

ne tähelepanu ka sellele, et kui
neel saada teilt tagasisidet, eriti
utab ettepanekuid ja soovitusi,
ubada, et sellele kohe vastame

alliance'i haldab Anatrack Ltd.

ack Ltd, 52 Furzebrook Road, V
et, BH20 5AX, United Kingdom

44 (0)1929 553759

Faks: +44 (0)1929 553761

Topics

Arable farming & grazing
livestock

Forestry or other tree cultivation
for timber/fuel/fibre

Gardening and horticulture,
including orchards and vineyards

Aquaculture or fishery for food

Fishing in rivers, lakes and the sea

Hunting and game management

Foraging for natural products

Nature watching & photography

Managing nature reserves or
other culturally important areas

Horse care for work and pleasure

Hounds and dog walking

Managing bees and pollination

Exercise in the countryside

Naturalliance aims to provide the knowledge you need, in your own language, to conserve and restore biodiversity for the benefit of all who use the countryside for work or recreation.

▶ [Find out more about Naturalliance](#)

▶ [Explore the Naturalliance topics](#)

▶ [Investigate tools for monitoring habitats and species](#)

▶ [Register with Naturalliance or login to access premium content](#)

Topics

Uprawa roślin i wypas zwierząt

Leśnictwo lub inne uprawy drzew na drewno / paliwa / włókno

Ogrody i ogrodnictwo, w tym sady i winnice

Akwakultura i rybołówstwo

Łowienie ryb w rzekach, jeziorach i morzu

Myślistwo i gospodarka łowiecka

Zbiór naturalnych produktów

Obserwowanie i fotografowanie przyrody

Zarządzanie rezerwatami przyrody lub innymi ważnymi kulturowo obszarami

Użytkowanie koni do pracy i dla satysfakcji

Psy gończe i spacerowe

Obserwowanie

W 2010 roku, wiejskie gospodarstwa domowe w ośmiu krajach Europy zostały zapytane o zajęcia, które zależą od bogactwa przyrody. Około połowa karmiła ptaki i inne zwierzęta w celu ich obserwacji, a większość z nich również organizowała wycieczki w celu obserwowania dzikich zwierząt.

Głównym celem Naturalliance jest pomoc w zachowaniu i ochronie dzikich zwierząt, których obserwowanie daje tak wiele satysfakcji, a także by pokazać jak wszyscy zainteresowani mogą wnieść swój drobny wkład, aby przywrócić to co nieświadomie zostało utracone. Zasadą jest, że lokalne społeczności właściciele również powinni korzystać, gdy inni cieszą się bogactwem natury na ich terenach.

NAJLEPSZA PRAKTYKA. Przykład korzyści lokalnej społeczności wynikających z obserwowania przyrody.

PRODUKCJA. Bogactwo przyrody zależy od tego jak my wszyscy użytkujemy grunty i gatunki. Jak możemy sprawić, by większa liczba osób uzna iż warto wnieść swój wkład?



Dokarmianie może zastąpić utracone siedlisko dla zięby.

Resource

► Best Prac

Translation

[Home](#) - Return to the editor home page

[Users](#) - Create edit and suspend users

[Transactions](#) - View user payments

[Topics](#) - Create and edit topics

[Topic Subpages](#) - Create and edit subpages

[Topic Links](#) - Create and edit subpage links

[Habitat/Species Links](#) - Create and edit habitat/species links

[Surveys](#) - View survey results

[Translations](#) - Translate pages and data

Select a resource set such as a page then select elements within the set to translate. Elements that are shown in red have not been translated into the specified language. Click **Save** to save each change before moving on to the next element.

Resource set:

About Page

Elements to translate:

About Aims1 Text
 About Aims2 Text
 About Aims3 Text
 About Aims4 Text
 About Aims5 Text
 About Aims6 Text
 About Aims Title Text
About Introduction1 Text
 About Introduction2 Text
 About Introduction3 Text
 About Introduction4 Text
 About Mapping1 Text
 About Mapping Link Text
 About Mapping Title Text
 About Register1 Text
 About Register2 Text
 About Register3 Text
 About Register4 Text
 About Register5 Text
 About Register6 Text
 About Register7 Text
 About Register Link Text
 About Register Title Text

Text to translate:

About Introduction1 Text

en: Humans evolved for many millennia as hunter-gatherers. In a much shorter time span since the last ice-age we started to cultivate many wild plants and animal live-stocks. This innovation let human populations grow and develop large settlements with specialised technologies. All these increased our pressure on the world's natural resources, such that fertile land is dominated by a few domesticated species that produce food and other materials for expanding towns and cities.

el: Ο άνθρωπος έχει εξελιχθεί επί χιλιετίες εκμεταλλευόμενος τα πλούτη που του προσφέρει η φύση. Εκτός από την άμεση συλλογή

Language to translate into:

Estonian (et)

Translation:

Inimene kui liik kujunes välja aastatuhandete vältel küttide ja korilastena elades. Palju lühema aja, alles viimasest jääajast alates, oleme me kasvanud taimi ja pidanud kariloomi. See uuendus võimaldas inimkonnal kasvada ja moodustada suuri asundusi, kus rakendatakse mitmesuguseid tehnoloogiaid. Kõik see on aga kasvanud meie survet Maa loodusvaradele, mille tulemusena näiteks domineerivad viljakatel maadel üsna vähesed kodustatud liigid, mis annavad meile toitu ja muud linnade kasvamiseks vajalikku.

Anatrack mapper for TESS with user-friendly principles of Ranges software

<value>Pour agrandir la carte</value>

<comment>Zoom in to the map</comment>

Thanks to editing
by partners in Excel,
the mapper is now
in 10 languages.



TESS Mapper - Garden Cottage, Boxwell - 21 Apr 2010 03:30:37

File Help

Mapping Type

- Deciduous woodland
- Coniferous woodland
- Rough grass
- Buildings
- Grave
- Fresh water

Mapped Objects

1. Fresh water
2. - hole
3. Buildings
4. Deciduous woodland
5. Red fox
6. Coniferous woodland

Area Details

Type: Buildings

Points: 8

Area: 104.67 m2

Area Points

51°37'58.4" N, 02°16'04.4" W
51°37'58.7" N, 02°16'04.2" W
51°37'58.6" N, 02°16'04.1" W
51°37'58.7" N, 02°16'04.0" W
51°37'58.6" N, 02°16'03.7" W
51°37'58.3" N, 02°16'03.9" W

51°37'58.0" N, 02°16'04.4" W No GPS device Selected point 4 in object 3. Buildings Add, edit or delete mapped objects

Maps from farmers

Do payments to farmers under the Common Agricultural Policy subsidy rules require a map from the farmer?

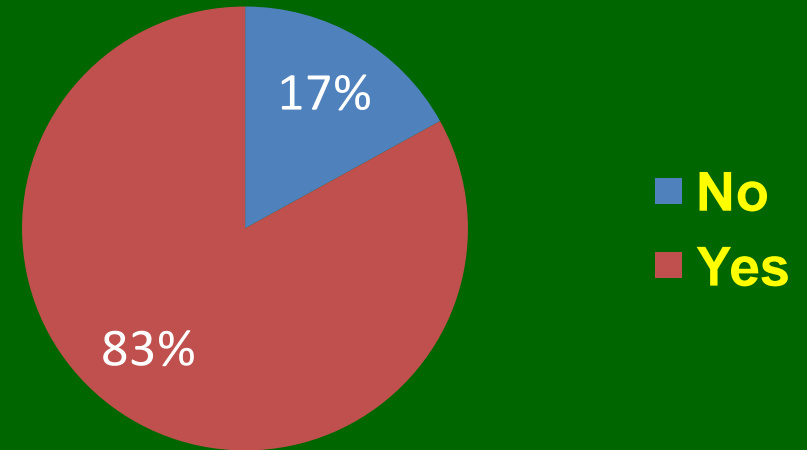

If 'yes', can this be in electronic format?

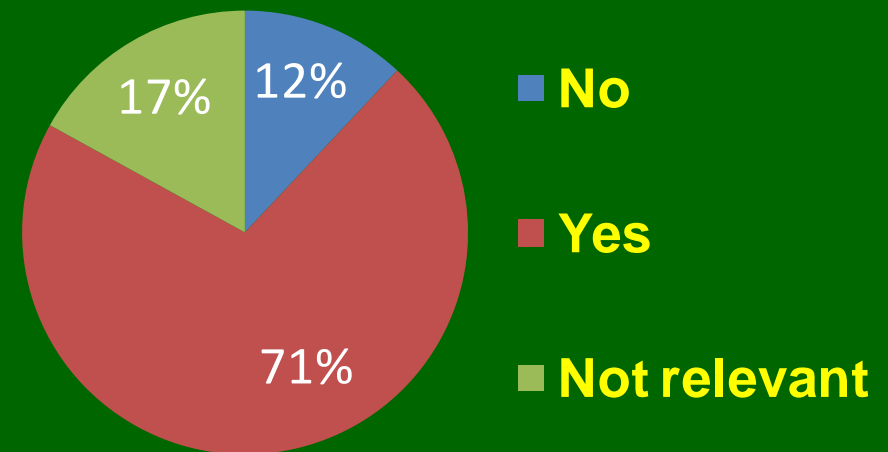



**Thank you
for listening**

www.tess-project.eu



Mapping Software

Feb 2009. Anatrack builds using principles in Ranges (user-friendly software for radio-tracking analyses)

May 2010: Translation-Editing in Excel

```
</data>
```

```
<data
```

```
  name="MapControl_pbZoomIn_ToolTip"
```

```
  xml:space="preserve">
```

```
  <value>Pour agrandir la carte</value>
```

```
  <comment>Zoom in to the
```

```
  map</comment>
```

Thanks to partners now in 10 languages

Hardware

Needs: Screen readable in sunlight, robust, low weight, GPS, camera, mobile internet, 5 h battery, low cost.

Anatrack provided software support for the Motion J3400 at ca. **€2,200.**

Also used: Algiz 10/7: operating temperature – 10 to +60 ca. **€3,045**

New on the block: 7" <€1000 tablets for consumers (Samsung Galaxy runs Android)

